

# ALUCOBOND®

## FIRE SAFETY OF FAÇADE CLADDING

Selecting the right materials to keep people safe is essential.



**3A**  
COMPOSITES

# CONTENTS

---

## **INTRODUCTION TO RAINSCREEN CLADDING**

- 4 General
- 5 Supporting substrate frame
- 5 Thermal insulation
- 5 The air gap and the firestop
- 5 Substructure
- 5 Cladding

## **THE ADVANTAGES OF THE REAR VENTILATED FAÇADE**

- 6 Protection against condensation and mould
- 6 Thermal protection in winter
- 6 Indoor heat storage
- 6 Thermal protection in summer
- 6 Protection of the load-bearing wall
- 6 Protection against rain
- 6 Recycling

## **NOTIONS OF FIRE**

- 7 Classifications in fire regulations
- 7 Building categories
- 9 Fire reaction
- 15 Fire resistance

## **TYPES OF RAINSCREEN CLADDING MATERIALS**

- 16 HPL
- 16 Mineral composite panels
- 16 Fibre cement
- 16 Panels made from stone wool fibres
- 16 ACP or ACM

## **CLADDING PERFORMANCE IN THE EVENT OF FIRE**

- 17 General
- 17 Comparison of PCS values

## **DEBRIS**

- 19 General

## **TOXICITY**

- 21 General

## **BONDED STIFFENERS**

- 23 General

# INTRODUCTION

Residential buildings, Medium- or High-rise buildings, Public buildings (ERP), it is sometimes complex to know what the rules are to apply in terms of fire safety and how to apply them.

As experts in aluminium composite façade cladding (ACM), it is our duty to inform you, to guide you, in a simple and clear manner, in order to avoid the use of products that are not suited to your type of project.

## INTRODUCTION TO RAINSCREEN CLADDING

A ventilated facade is a facade construction with an air gap between the insulation and the cladding. This gap is open at the top and bottom, and the covering also has small open joints. The temperature being lower at the top than at the bottom, this creates natural ventilation of the facade from bottom to top. The ventilation zone regulates the temperature, decreases the thermal amplitude, it saves energy and extends the life of the materials.

Components of rainscreen claddings:

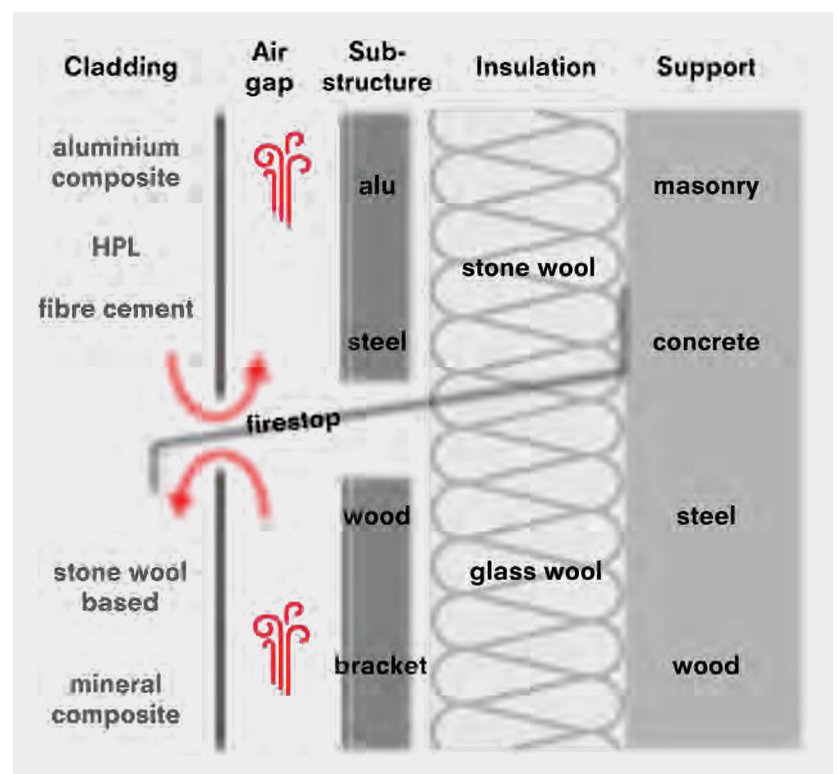

## INTRODUCTION

### **Supporting substrate frame (support)**

The supporting substrate frame is the load-bearing structure of the building. It takes the loads applied by the facade. The substructure is anchored to the supporting structure. Surface layers (e.g. plaster and coatings) can usually not support loads.

### **Thermal insulation**

The thermal insulation is the thermally insulating layer between supporting substrate frame and rear-ventilation zone. Depending on the material used, the thermal insulation may also fulfil functions related to fire protection and sound insulation.

### **The air gap and the firestop**

The air gap (rear-ventilation zone) is a space between the inner face of the cladding and the front face of the wall or the thermal insulation through which outside air flows. Its functions are to protect the layers beneath from moisture, to drain rainwater and condensation, and to reduce heat accumulation in the summer (temperature buffer in both summer and winter). However the ventilation may cause a “chimney effect in case of fire. Firestops prevents the “chimney effect”, it compartmentalises or closes the air gap behind the facade, and limits the spread of smoke and smoke.

### **Substructure**

Light aluminium, steel, wood, compensates for irregularities in the shell and supports the exterior cladding.

### **Cladding**

Claddings consist of elements with open or closed/underlaid joints or of abutting or overlapping elements. They function as weather protection and are a feature of the facade design; it offers a multitude of aesthetic possibilities.

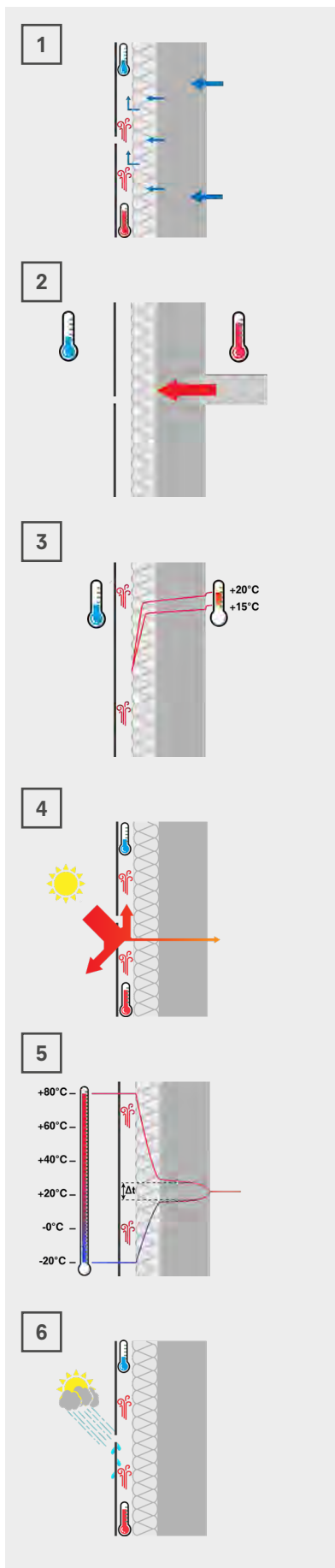

## THE ADVANTAGES OF THE REAR VENTILATED FAÇADE

### 1. Protection against condensation and mould:

There is nothing to prevent the diffusion of steam, there are no problems with mould and humidity, because the facade is "self-breathing".

### 2. Thermal protection in winter:

The thermal insulation located outside the building allows complete insulation, without thermal bridges at the slab's level and the partition walls. The brackets penetrating the insulation, creates only point thermal bridges instead of linear one, limited by lighter cladding, less brackets therefore less cold bridging.

### 3. Indoor heat storage:

The mass of thermal storage in walls and ceilings dampens temperature variations, thus improving comfort in rooms.

### 4. Thermal protection in summer:

The external thermal insulation protects against summer heat. The air gap allows excessive heat to be vented upwards.

### 5. Protection of the load-bearing wall:

The external thermal insulation protects from cracks due to temperature fluctuations. The cladding expands freely and avoids direct contact between the wall and climate change, thereby improving the durability of the building.

### 6. Protection against rain:

The evacuation of water in the cavity and the evaporation of all other humidity is carried out by the rear ventilation zone. If the facade is wet in the air gap due to the open joints, then the humidity evaporates naturally thanks to the ventilation.

### 7. Recycling:

The ventilated facade makes it possible to separate each component easily; the façade materials used are therefore also separable during disassembly, thus facilitating their recycling.



# NOTIONS OF FIRE

---

## NOTIONS OF FIRE

To appear and spread, fire physically needs three elements:

- a heat source (source of the fire)
- an oxidizer: generally, oxygen
- a fuel (material)

Under the action of a heat source which reaches a critical temperature, called the ignition temperature, fire appears during the combustion between the oxygen in the ambient air and a solid, liquid or gaseous fuel.

If a material enters into combustion, the generated heat transfers simultaneously by radiation, convection and conduction. It is therefore important to classify materials according to their combustibility and their application.

### **Classifications in fire regulations**

The fire safety requirements are based on the fire development curve.

The fire classifications are divided into 3 parts:

- Building categories
- Reaction to fire
- Fire resistance

### **Building categories**

The use in relation to the building type determines the requirements to be applied in terms of fire safety design. At the beginning of a construction project and during the planning phase, the designer must define the operational and building technical class that the building must comply with.

- Dwellings: the building regulation 2019, approved document B, volume 1
- Buildings other than dwellings: the building regulation 2019, approved document B, volume 2

## NOTIONS OF FIRE

**Table 12.1 Reaction to fire performance of external surface of walls**

Building type	Building height	Less than 1000mm from the relevant boundary	1000mm or more from the relevant boundary
'Relevant buildings' as defined in regulation 7(4) (see paragraph 12.11)		Class A2-s1, d0 <sup>(1)</sup> or better	Class A2-s1, d0 <sup>(1)</sup> or better
Assembly and recreation	More than 18m	Class B-s3, d2 <sup>(2)</sup> or better	From ground level to 18m: class C-s3, d2 <sup>(3)</sup> or better From 18m in height and above: class B-s3, d2 <sup>(2)</sup> or better
	18m or less	Class B-s3, d2 <sup>(2)</sup> or better	Up to 10m above ground level: class C-s3, d2 <sup>(3)</sup> or better Up to 10m above a roof or any part of the building to which the public have access: class C-s3, d2 <sup>(3)</sup> or better <sup>(4)</sup> From 10m in height and above: no minimum performance
Any other building	More than 18m	Class B-s3, d2 <sup>(2)</sup> or better	From ground level to 18m: class C-s3, d2 <sup>(3)</sup> or better From 18m in height and above: class B-s3, d2 <sup>(2)</sup> or better
	18m or less	Class B-s3, d2 <sup>(2)</sup> or better	No provisions

**NOTES:**

In addition to the requirements within this table, buildings with a top occupied storey above 18m should also meet the provisions of paragraph 12.6.

In all cases, the advice in paragraph 12.4 should be followed.

1. The restrictions for these buildings apply to all the materials used in the external wall and specified attachments (see paragraphs 12.10 to 12.13 for further guidance).
2. Profiled or flat steel sheet at least 0.5 mm thick with an organic coating of no more than 0.2mm thickness is also acceptable.
3. Timber cladding at least 9mm thick is also acceptable.
4. 10m is measured from the top surface of the roof.

Note: fire classes according to BS EN 13501-1



# NOTIONS OF FIRE

## Fire reaction

National classifications have long been used in the design of building facades. But the recent Grenfell tragedy (London) has ended their use on construction projects. The "class 0" for linings in Great Britain or the "M classification" in France only covers the flame spread on the material. For example, the Aluminium Composite Material (ACM) with a Polyethylene Core (PE core) used on the Grenfell building was a class 0 material (class D according to BS EN 13501-1) in combination with minimum limited combustible insulation, while the ACM FR or A2 (Fire Retardant or Non Combustible), which would have made it possible to avoid this tragedy, would also have been a class 0. There was no differentiation between safe and risky materials, which led to the use of the cheapest product: ACM PE.

Governments have understood this now, after comparing the different national and European test methods. This has led authorities to replacing their national classification with the European classification according BS EN 13501-1, known as "Euroclasses", which covers the different phases of the fire.

A product classified Euroclasses which has undergone European classification has to pass up to 4 test methods which simulate the first 3 phases of fire development:

### Development and propagation of the fire over the time

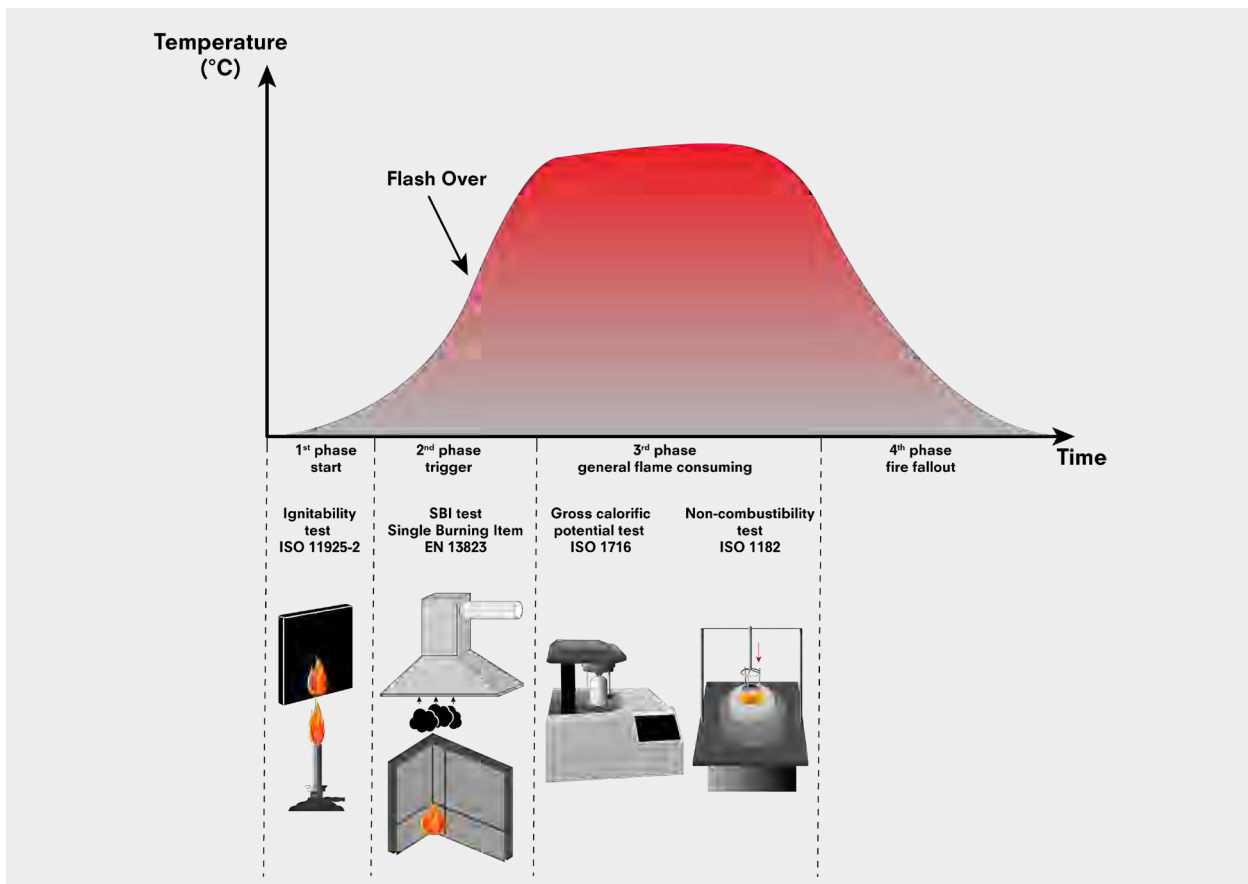



## NOTIONS OF FIRE



### Ignitability test ISO 11925-2

The purpose of this test is to assess the flammability of a sample placed vertically and subjected to a small flame (0.8 kW) attacking the edge and/or the surface of the material at an angle of 45°. Flame exposure for 15 or 30 seconds.

A small receptacle containing two layers of filter paper is placed under the material to be tested, in order to collect any droplets and/or flaming debris and to determine the flammability of the filter paper.

During and after the attack of the flame, flame travel is inspected to ascertain if it reaches 150mm mark during the test time of 20 or 60 seconds after exposure, following the class to reach.

### SBI test (single burning item) EN 13823

This SBI test is used to estimate the contribution of a material to the spread of a fire. This is simulated using a burning object placed in the corner of a room and transmitting a flow of heat to the neighbouring walls.

The material is placed against two vertical walls of unequal dimensions, forming a 90° angle. The small panel measures 0.5 m x 1.5 m, the large 1 m x 1.5 m. The test piece is exposed for 20 minutes to the flames of a burner with an intensity of approximately 30 kW, located in the interior corner of the two walls.

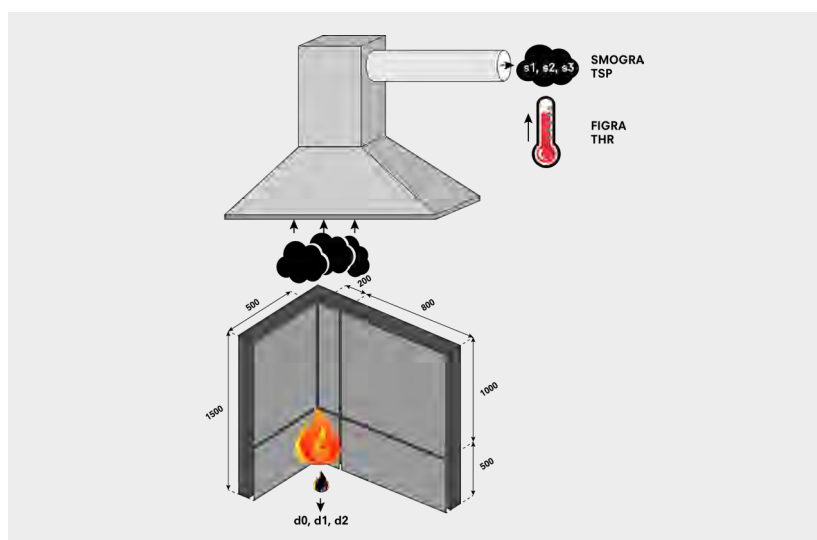

The classification parameters of the SBI test are fire growth rate index (FIGRA), lateral flame spread (LFS), and total heat release (THR600s). Additional classification parameters are defined for smoke production as smoke growth rate index (SMOGRA) and total smoke production (TSP600s), and for flaming droplets and particles according to their occurrence during the first 600 seconds of the test.

## NOTIONS OF FIRE

### Gross calorific potential test ISO 1716

This method makes it possible to determine the maximum quantity of heat emitted by the complete combustion of a material, quantity of heat which is called "calorific potential" and is expressed in MJ/kg.

The calorific potential is calculated on the basis of the rise in temperature, taking into account the heat losses and the latent heat of the water vapour.

A specified mass (generally 0.5 g) of the pulverized or fragmented product is placed in a crucible, mixed with an identical amount of combustible additive (paraffin oil). Ignition cables are introduced into the support, which is in direct contact with the test piece. Once the support is placed in the high-pressure calorimetric bomb, it is filled with oxygen, then subjected to increasing pressure until it explodes.

The heat potential in MJ/kg is then converted to MJ/m<sup>2</sup> according to the weight and thickness of the material, this value is very important to determine how safe the rainscreen cladding is.

### Non-combustibility test ISO 1182

The test is carried out on cylindrical specimens 45 mm in diameter and 50 mm in height, held vertically by a support in an oven at 750 ° C. Thermocouples measure the oven temperature.

The test continues for 60 minutes or until the temperature equilibrium is reached. Three classification criteria are defined on the basis of the temperature rise ( $\Delta T \leq 30^\circ \text{C}$  or  $50^\circ \text{C}$ ), the loss of mass ( $\Delta m \leq 50\%$ ) and the duration of ignition (0 or  $\leq 20$  seconds).

From the results of these different tests, the Euroclass classification is determined with the following 3 criteria:

- Contribution to fire:
  - A1 and A2: no significant contribution to fire = non-combustible material
  - B: very limited contribution to fire = low fuel material
  - C: limited contribution to fire = combustible material
  - D: medium contribution to fire = combustible material
  - E: significant contribution to fire = combustible material satisfying the ignition test for 20 seconds
  - F: material not classified or easily flammable
- Smoke opacity (s for "smoke"):
  - S1: very low smoke production
  - S2: limited smoke production
  - S3: high smoke production

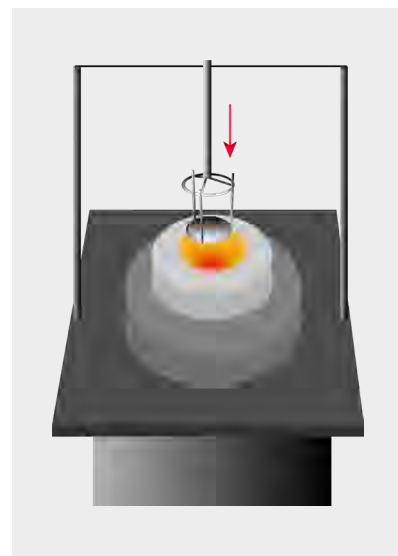

## NOTIONS OF FIRE

- Dripping (d for "droplet"):
  - D0: non-existent flaming droplets
  - D1: persistent flaming droplets up to 10 seconds
  - D2: flaming droplets

Summary:

ALUCOBOND® PLUS (class B-s1,d0) is a material with very limited contribution to fire, low fuel material, with very low smoke production, non-existent flaming droplets.

ALUCOBOND® A2 (class A2-s1,d0) is a material with no significant contribution to fire, non-combustible material, with very low smoke production, non-existent flaming droplets.

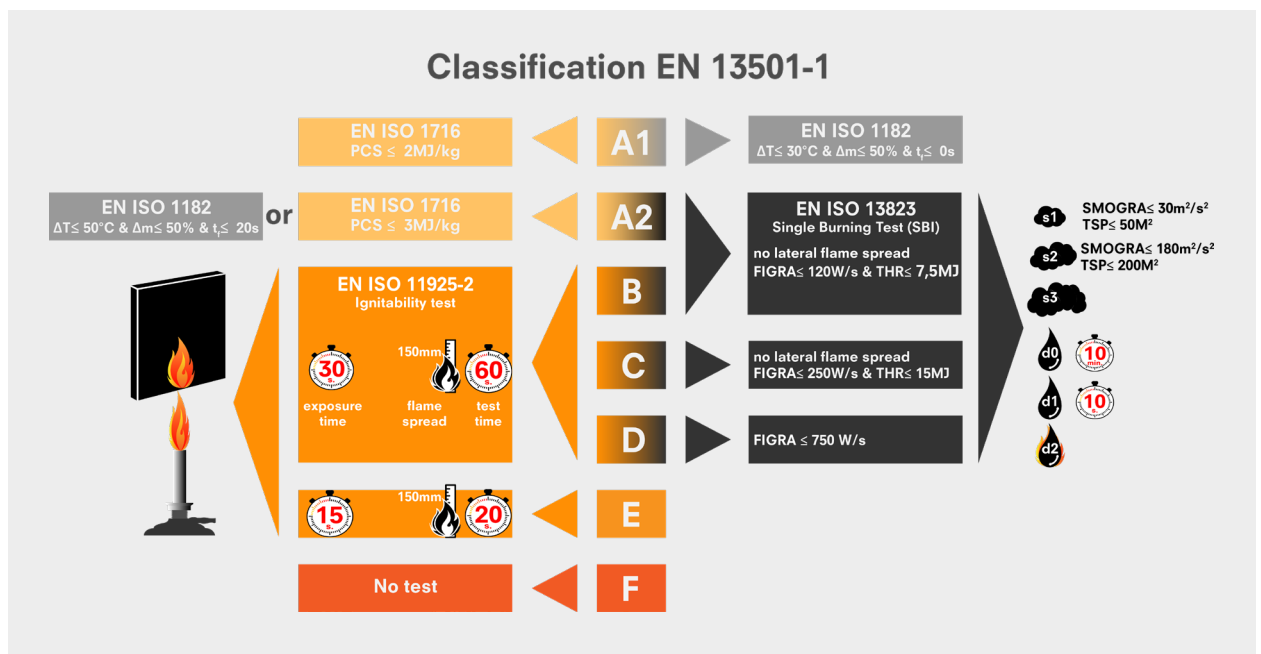

There are some particular cases, for example A1 coated building material (e.g. painted solid metals) requires an SBI test in order to check the fire behaviour of the painted surface.

## NOTIONS OF FIRE

### BS 8414 large scale tests

BS 8414 tests simulate the scenario of flames emerging from a compartment fire via a window at the base of the wall (crib  $\approx$  400kg wood  $\approx$  300kW).

Part 1 is made with masonry.

Part 2 is made with light frame.

Test duration: Exposure 15 minutes / Observation 30 minutes

Failure criteria in UK:

- Temperature above 600°C at level 2, for a period of at least 30s within 15 minutes.
- Additional: early termination of the test, if visible flaming exceeds the edges of the test rig within 30 minutes.

### Test rig according to BS8414 2015

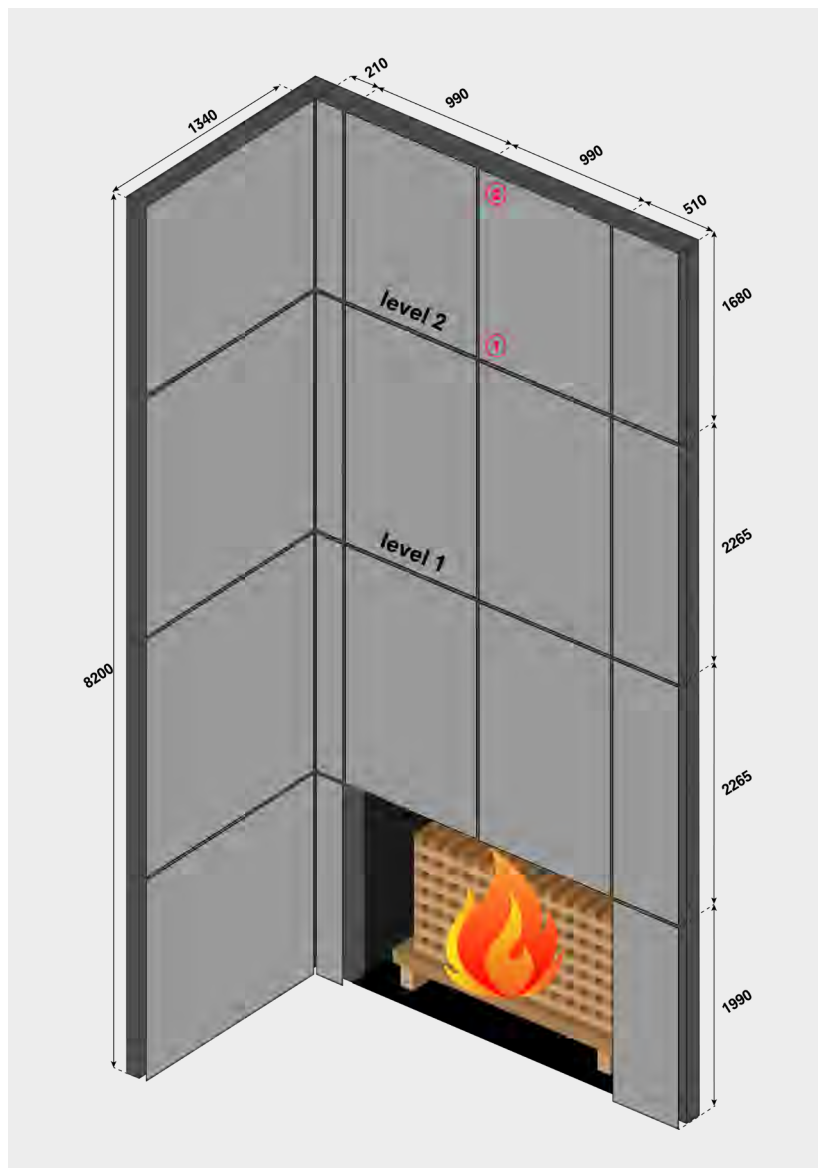

## NOTIONS OF FIRE

Comparison of the fire source power of different tests:

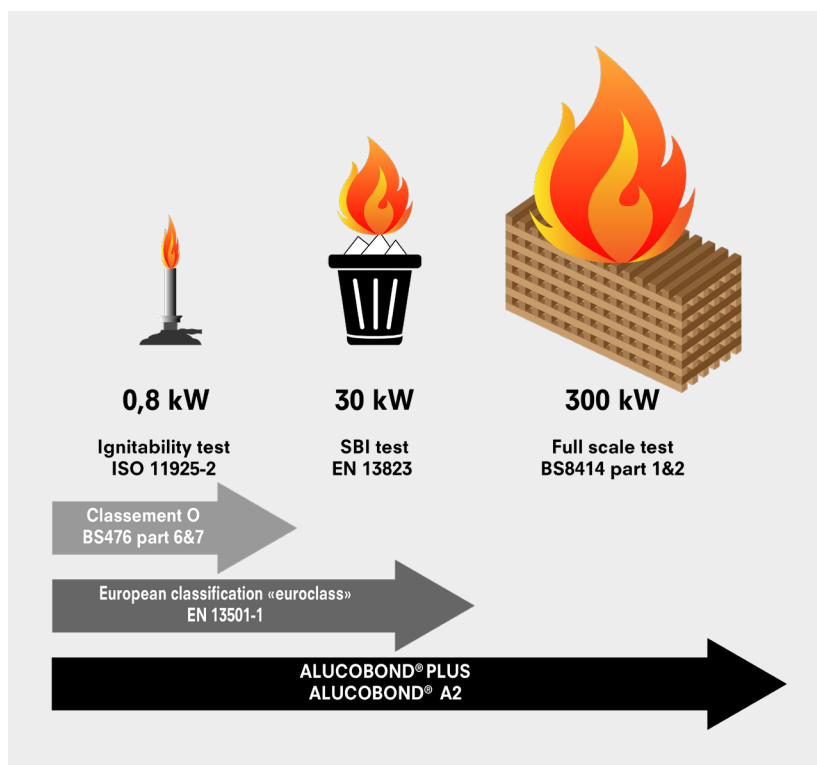

ALUCOBOND® completed full scale tests in accordance with BS 8414 and then in getting an assessment in accordance with BR 135:

ALUCOBOND®	System	Substrate	Insulation	Cavity barrier
PLUS	Riveted	Stud wall	Rockwool duoslab 80mm	Siderise Lamatherm RH25
PLUS	Tray panel	Masonry	Rockwool duoslab 80mm	galvanised mid steel
PLUS	Tray panel	Stud wall	Rockwool duoslab 80mm	galvanised mid steel
A2	Tray panel	Masonry	Rockwool duoslab 80mm	galvanised mid steel
A2	Tray panel	Stud wall	Rockwool duoslab 80mm	Siderise Lamatherm RH25

## NOTIONS OF FIRE

### Fire resistance

Fire resistance is a classification which indicates how long the construction system can resist a fire after the flashover, between 2 rooms or between 2 buildings.

The European classification which is based on 4 criteria with a time in minutes (15-30-60-90-120-180-240 minutes), only 3 criteria are relevant for cladding systems.

#### Resistance R applied to load-bearing elements

R = Mechanical resistance or bearing capacity

Criteria according to which the ability of the element or structure to withstand specified loads and / or actions is determined. The building element must withstand exposure to fire, under mechanical actions, without loss of structural stability.

- Loss of stability
- Deformation speed or deflection (beams)
- Vertical deformation (columns, walls)

#### Resistance E applied to the separating elements

E = Flame and hot gas control

Integrity demonstrates the ability to prevent flames or hot gases from passing through the partition when one side is exposed to fire.

- No flames going through (cotton ignition)
- No critical cracks

#### Resistance I applied to the separating elements

I = Thermal insulation

Criteria according to which the ability of a separating element to prevent the passage of heat is determined. The element must provide sufficient thermal insulation to protect persons in the vicinity.

- $\Delta T_{\max} \leq 180^{\circ}\text{C}$
- $\Delta T_{\text{average}} \leq 140^{\circ}\text{C}$

Rainscreen cladding doesn't need to provide fire resistance. In case of rainscreen cladding, fire resistance is ensured by the load-bearing wall and the insulation.

The fire resistance is required only for cavity barriers (Firestop).

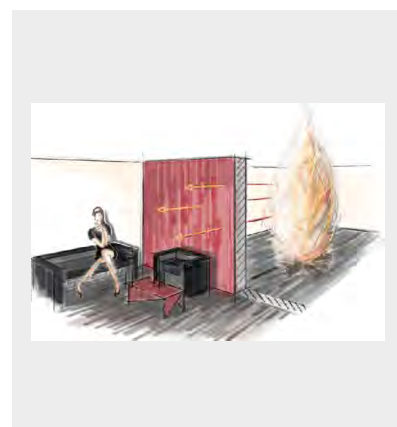
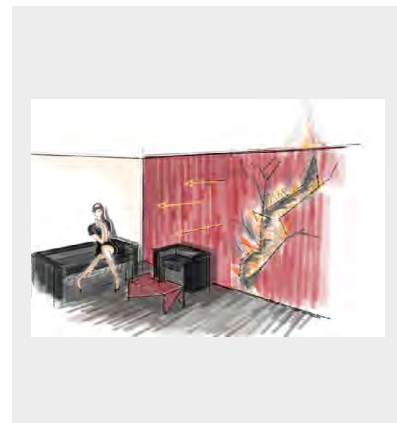
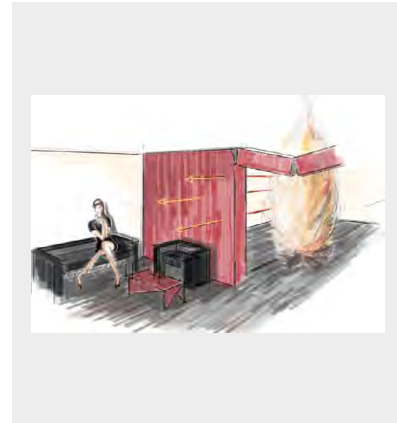

# TYPES OF RAINSCREEN CLADDING MATERIALS

---

## WHAT ARE THE DIFFERENT TYPES OF RAINSCREEN CLADDING MATERIALS?

**HPL (High Pressure Laminate)**, consist of wood or paper fibres (60-70%), with the addition of a binder based of phenolic resin (30-40%). All of these components are inherently combustible and therefore have a poor reaction to fire. It can however be improved by adding flame retardants (HPL FR), but the calorific potential of these materials remains high. "HPL A2", is a mineral filled panel with an HPL surface. It is a panel with low calorific potential and a good performance regarding reaction to fire.

The **mineral composite panels** are facing plates moulded in polyester resin mortar. The large proportion of resin which is inherently combustible, gives a significant heat potential. However, it can be improved by adding flame retardants, but the calorific potential of these materials remains high.

**Fibre cement** is a composite material composed of a homogeneous mixture of cement, sand and cellulose. The fibre cement has a low calorific potential, and therefore a good performance regarding reaction to fire.

**Panels made from stone wool fibres** and thermosetting resins. It is a panel with low calorific potential and a good performance regarding reaction to fire. In general, the stone wool primarily made from basalt, a volcanic rock, it has the particularity of being able to accumulate heat (high thermal capacity) and to restore it gradually (rather low thermal conductivity), which, during a fire, can give the emergency services a longer period of time to combat the flames and prevent the fire from resuming. There is a risk of glowing combustion.

**ACP or ACM (Aluminium Composite Panels or Materials)** are panels made up of two sheets of aluminium, continuously painted and bonded on either side of a core. There are 3 types of aluminium composite products on the market:

- Aluminium composite with PE core (100% Polyethylene) – These panels are combustible (class D-E according to BS EN 13501-1).
- Aluminium composite with FR core (approximately 70% mineral) – equivalent to ALUCOBOND® PLUS – These panels are treated with flame retardants and have a good performance regarding reaction to fire (class B according to BS EN 13501-1). Calorific potential (core)  $\leq 13,6$  MJ/kg according to the MHCLG 2020.
- Aluminium composite with A1/A2 core (minimum 90% mineral) – equivalent to ALUCOBOND® A2 – These panels are non-combustible and therefore have a very good performance regarding reaction to fire (class A1/A2 according to BS EN 13501-1). Calorific potential ACM A2  $\leq 3,0$  MJ/kg, calorific potential ACM A1  $\leq 2,0$  MJ/kg.



# CLADDING PERFORMANCE IN THE EVENT OF FIRE

## CLADDING PERFORMANCE IN THE EVENT OF FIRE

### Why is the combustible mass (heat potential PCS) of the coating materials important?

The heat potential is the amount of energy produced by the total combustion of a material. This amount of energy determines how much heat a given material brings to a fire. The greater the heat input, the greater the propagation of the fire. This value expressed in MJ/kg is converted to MJ/m<sup>2</sup> in the building envelope, for comparison.

### COMPARISON OF PCS VALUES

In general, the lower the calorific value (value of PCS in MJ/m<sup>2</sup>) of a product, the better it is for fire safety. With regard to the rainscreen systems, the value of the facade cladding and the value of the insulation used should be added together. We compared the fire load of the different cladding materials based on similar static values, and the fire load of different insulation in using the same thermal resistance U=0,2 W/m<sup>2</sup>K.

ALUCOBOND® A2 is one of the best possible facade cladding with only 17 MJ/m<sup>2</sup>.

ALUCOBOND® PLUS is a fire-retardant intermediate product that remains below 80 MJ/m<sup>2</sup>.

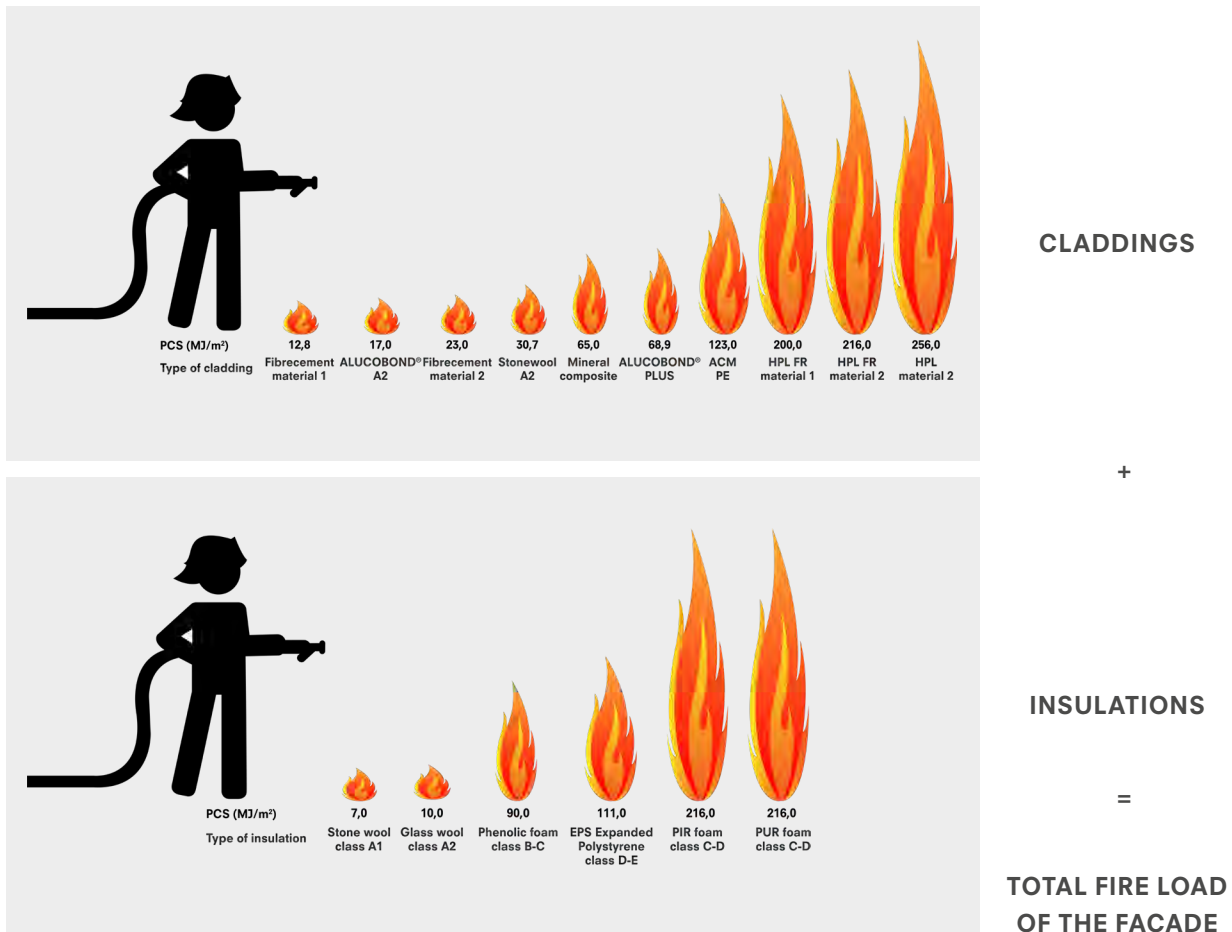

## CLADDING PERFORMANCE IN THE EVENT OF FIRE

### Estimation of the different fire loads on well-known fire events

The Grenfell tower block in London in 2017, was equipped with an ACM PE cladding in combination with PIR foam, adding the PCS values of the 2 materials (above), we get a huge total of  $123 + 216 = 339 \text{ MJ/m}^2$ .

The fire at the Adoma residential building for migrant workers in Dijon France in 2010, was equipped with ETICS/EWI on polystyrene foam. Fire load value of more than  $111 \text{ MJ/m}^2$ .

The fire of a student accommodation in Bolton in 2019. This building was equipped with an HPL cladding on PIR foam, we get a huge fire load of  $256 + 216 = 472 \text{ MJ/m}^2$ .

Lakanal House tower block in Camberwell in 2009. This building was equipped with an HPL cladding on polystyrene foam, we get a huge fire load of  $256 + 111 = 367 \text{ MJ/m}^2$ .

Using ALUCOBOND® A2 in combination with stone wool, we get a fire load of  $17 + 7 = 24 \text{ MJ/m}^2$ . Which is insignificant.

# DEBRIS

---

There are two reasons for considering debris:

1. No endangering of occupants and emergency service during evacuation of a building
2. No secondary fire from falling burning parts

The falling of facing elements, including the supporting structure, are progressive during the fire, in the form of pieces which, depending on the materials chosen, can be of limited size and weight and therefore without risk. Or it can be in significant quantity, heavy and therefore dangerous.

These falling objects remain in the imprint area of the flame, and for the ALUCOBOND® remain of limited size and weight.

**ALUCOBOND® is a material with low falling objects during a fire.**

This can be explained as follows:

During a fire, and during a BS8414 simulation, the part located in a lintel of the fire source reaches a temperature about 1000 °C, the materials used in this part of the facade (example below: surface of 1,7m<sup>2</sup>) burn, melt, explode or simply expand and, hence, cause the surrounding materials to rupture.

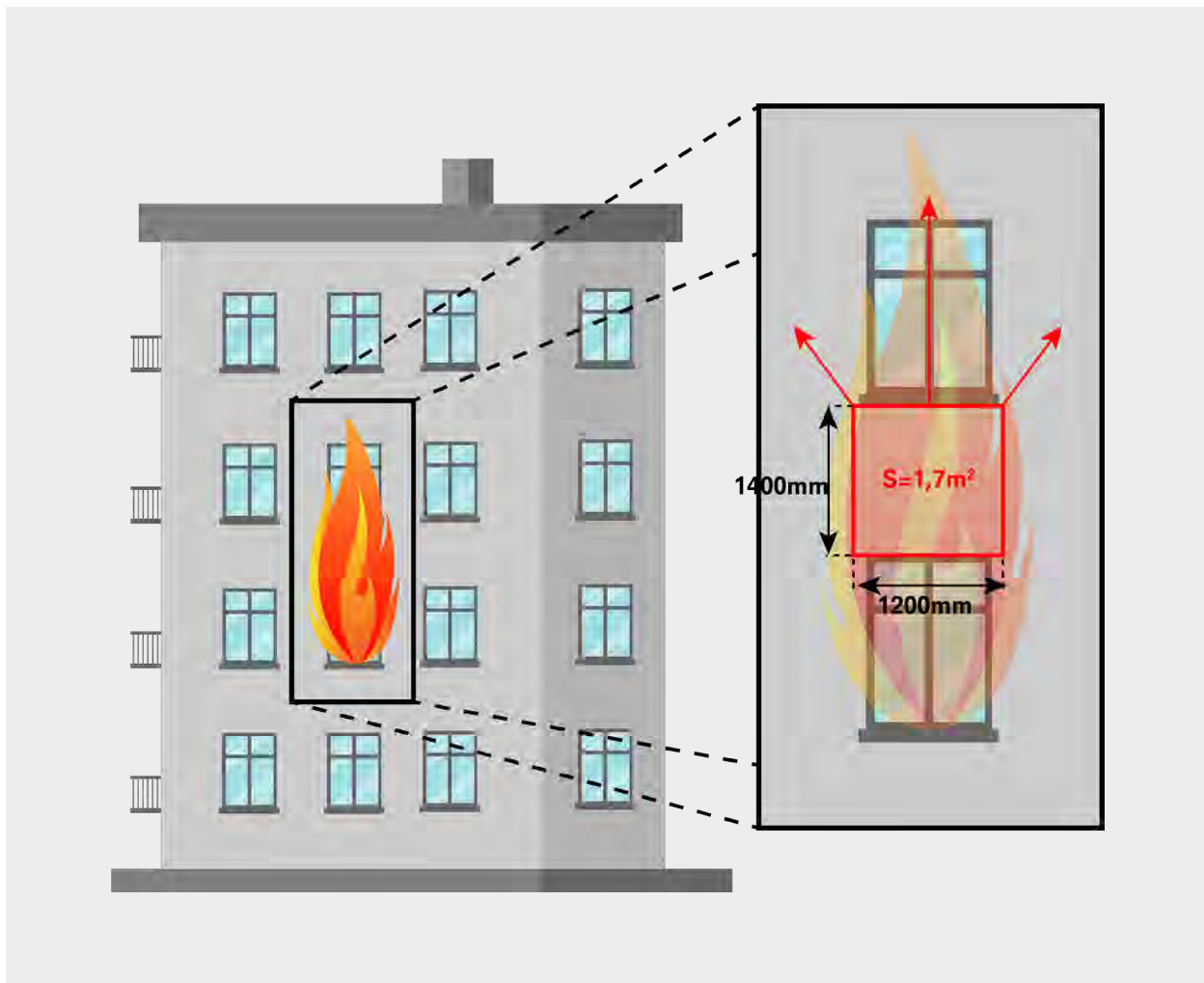

## DEBRIS

The fire classification plays a crucial role in limiting the exposed surface, a product classified B will have a larger surface destroyed than a product classified A2.

Fortunately, we can limit falling objects:

1. Using the lightest possible cladding. Because even materials with a good performance regarding reaction to fire (classification A1/A2) but heavy like ceramic or fibre cement or stone wool-based panels, etc. end up falling from this blue zone.
2. The use of light cladding leads to the use of smaller brackets and therefore limiting the weight of the objects. The ALUCOBOND® only needs the smallest brackets on the market.
3. Using a product with the largest possible span between rails, as this means fewer supporting profiles per m<sup>2</sup> and therefore less profile mass dropping. The ALUCOBOND® has a very good rigidity which allows large spans.

By analysing in detail, the test reports available (ex: MHCLG tests 8414), we note that the debris falls between the 10<sup>th</sup> and 30<sup>th</sup> minutes, no matter the insulation/cladding combination. It is therefore important to take into consideration the maximum weight and size of debris, beyond the first 10 minutes, but also to compare the facade elements according to the total weight of debris generated by the fire during the entire duration of the test.

Comparison of debris quantity during BS8414 test of different cladding materials:

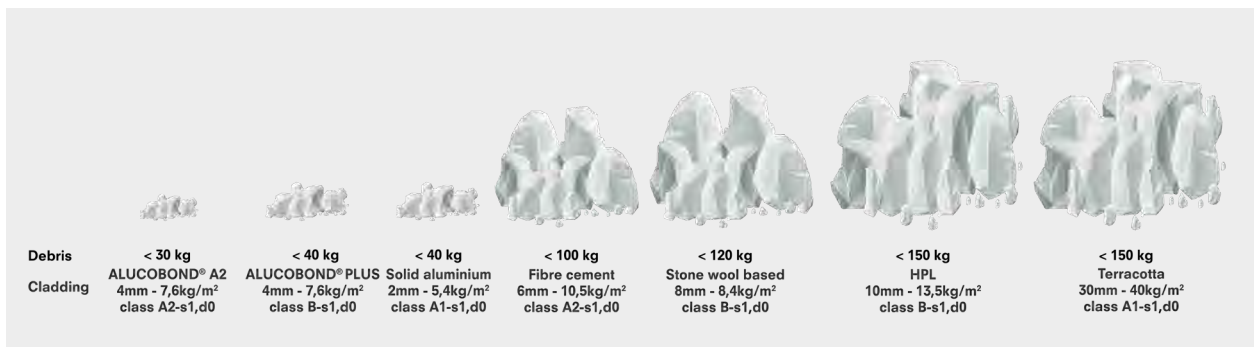

# TOXICITY

Often the requests concerning the toxicity of materials relate to health-related evaluation of indoor construction products (AgBB, version June 2012) for the emissions VOC (volatile organic compounds) and SVOC (semi-volatile organic compounds).

**According to the French VOC regulation, ALUCOBOND® PLUS and ALUCOBOND® A2 fulfills the requirements of the best category: class A+.**

In the event of a fire, the VOC and SVOC certificate is no longer relevant to guarantee the non-toxicity of the materials. The flames produce large volumes of smoke inside the building (furniture, appliances, paint, etc.), and also outside. In fact, smoke from the burning facade can enter the building before the content of each apartment ignites, through the ventilation ducts or simply through an open/broken window.

**Smoke inhalation is known to be the most important cause of death and the main cause of injury in the event of a fire!**

If exposed to smoke, the victim becomes incapacitated (unconscious), and unless saved, death is likely to follow. Incapacitation and lethality can be estimated in terms of Effective Fractional Dose (FED), in accordance with ISO 13571 (incapacity) or ISO 13344 (lethality).

When the FED is equal to 1, the equations predict that half of the exposed population would be incapacitated or killed.

ALUCOBOND® A2 complies with the requirements of railway coach and tunnels (e.g. LUL).

After Grenfell, there have been a lot of investigations about aluminium composite by independent laboratories. Not only in terms of fire spread, but also in terms of toxicity. This brings a considerable advantage to the ALUCOBOND® PLUS and ALUCOBOND® A2 products! Indeed, they are the only facade cladding materials that can prove their non-toxicity in the event of fire!

There are 2 different publications available on the internet comparing the toxicity of different aluminium composites (PE, FR and A2) in combination with different insulation materials:

- Cladding system toxicity study by Dr Jim Glockling  
<https://www.gov.uk/government/publications/fire-safety-approved-document-b>
- Study of fire behavior of facade by Efectis and the University of Ulster  
[https://efectis.com/wp-content/uploads/2018/05/Study\\_fire\\_behaviour\\_facadetest.pdf](https://efectis.com/wp-content/uploads/2018/05/Study_fire_behaviour_facadetest.pdf)

In this study, the insulation thicknesses are not representative of those used to meet the thermal regulations in force (about 50% lower), which tends to reduce the influence of the insulation compared to the

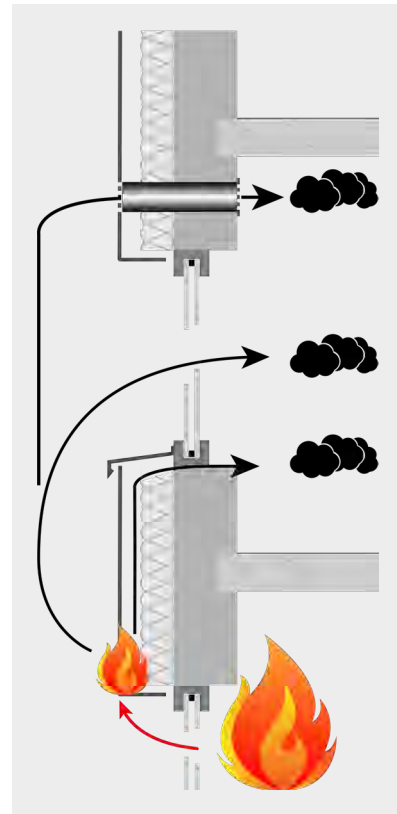

## TOXICITY

aluminum composite. But demonstrate, despite this, the non-toxicity of ALUCOBOND® PLUS (FR) and ALUCOBOND® A2, and that the choice of insulation is very important, mineral wools are recommended.

Contribution of CO and HCN to incapacitation (ISO 13571) at 30 minutes for gases entering a 50m<sup>3</sup> room from cladding through 100mm vent:

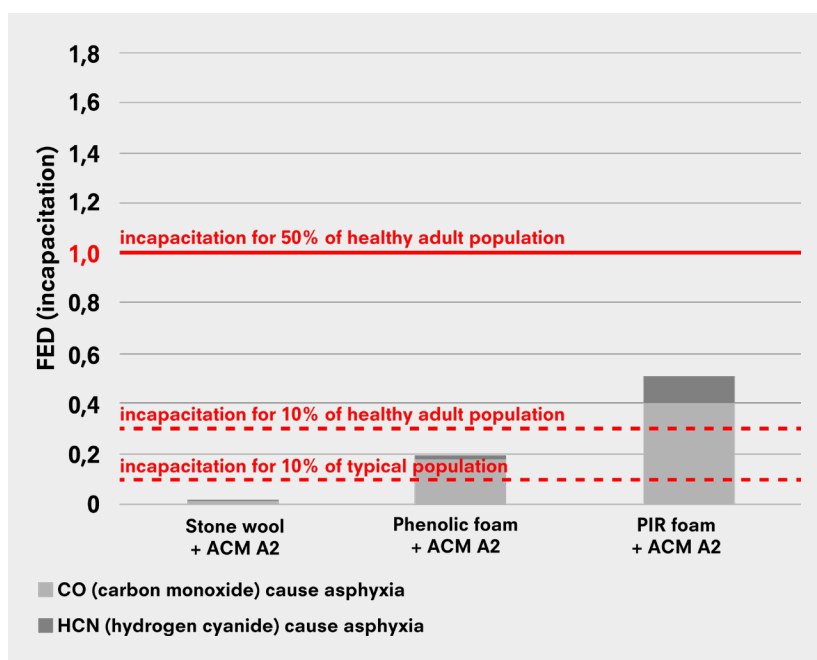

Contribution of CO, HCN, CO<sub>2</sub> and lack of O<sub>2</sub> to lethality (ISO 13344) at 30 minutes for gases entering a 50m<sup>3</sup> room from cladding through 100mm vent:

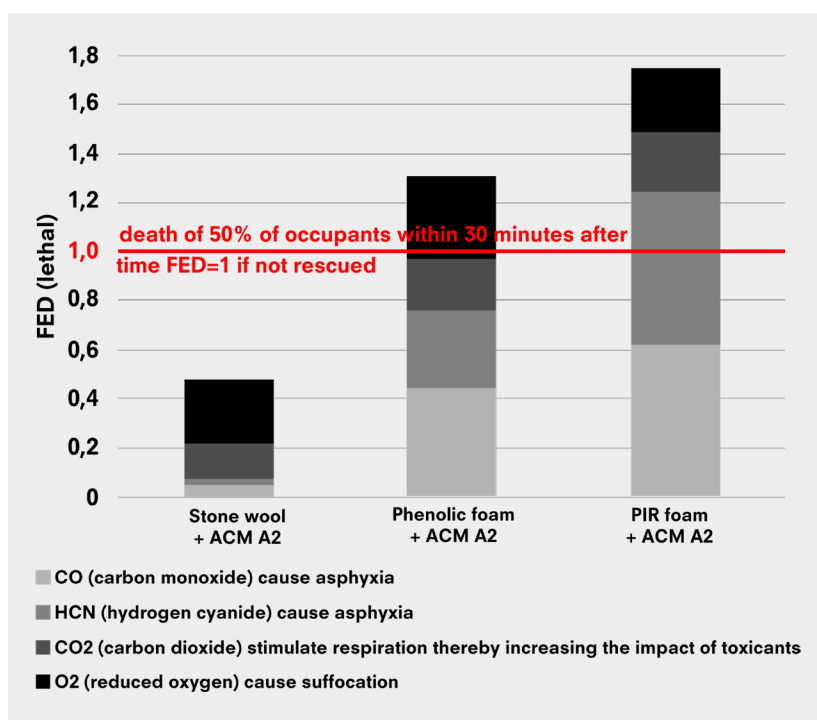

## BONDED STIFFENERS

The advantage of ALUCOBOND® is that the size of the cassettes can increase even under heavy wind loads, by bonding one or more invisible stiffeners to the rear side of the tray panel (blue dotted lines).

In order to check the influence of adhesive, a flammable product, on the fire performance of our products. ALUCOBOND® PLUS and A2 have therefore been tested, by an approved laboratory, to validate the addition of several bonded stiffeners, thus proving that our materials keep their classification in this configuration. We are the first and only cladding supplier to guarantee this:

- ALUCOBOND® A2 with stiffeners:  
class A2-s1,d0 (certificate n°319082903-A.REV1)

### Ask yourself the right questions!

### Some advice before choosing the facade materials for your project:

#### 1. For all types of materials

Always ask for the full Euroclass certificates, with the field of application included, then check the following points:

- Is the frame (wood or metal) part of the field of application?
- Is the insulation similar to my project? In terms of fire classification, thickness and density
- Do the gap between panels respect the field of application?
- Does the air gap respect the field of application?
- Does the thickness of the lacquer correspond to the field of application?

Always ask for the full classification report in accordance with BR135 of the cladding product used, as it gives important information concerning its field of application and also the duration of the test (some test reports show a 10 minutes test duration, hiding what happens after: fire propagation and debris). The system must be tested to full duration (Exposure 15 minutes / Observation 30 minutes) and met the requirements.

#### 2. For aluminum composites in particulars

You should know that **the aluminum composite is the only cladding material tested regularly to control its fire load (PCS value)**, this as part of the BBA certification, audits and external surveillances. The goal is to be sure that the composite installed on your project will have a stable and correct fire load.

- Is the core manufactured by the manufacturers themselves or is it prefabricated by an external source? What are the certificates / checks for the core if it comes from an external source?

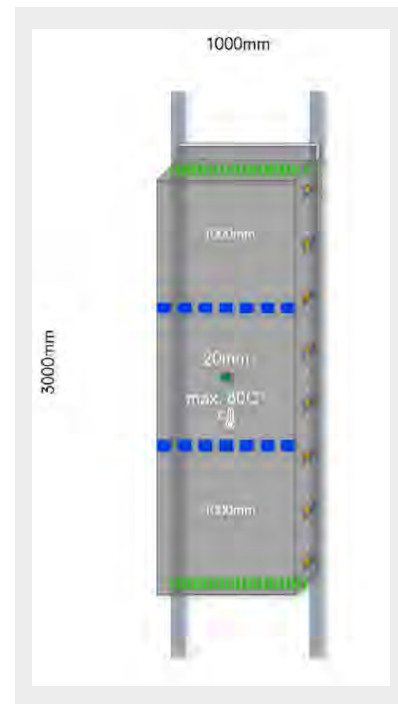



## BONDED STIFFENERS

### 3. How to analyze the weaknesses of the construction system during a fire?

It is relatively simple visually to know the reasons leading to the different types of facade fire:

- If the fire is contained between 2 floors: Good compartmentalization between the 2 floors, low fire load of the insulation and cladding, effective cavity barriers.
- If the fire spreads quickly over several floors behind the cladding, in the air gap: low fire load of the cladding, the insulation fire load has to be checked, non-existent or ineffective cavity barriers.
- If the fire spreads quickly over several floors in front of the cladding: significant fire load of the cladding, the insulation fire load has to be checked, cavity barriers have to be checked.
- If the fire spreads quickly over several floors and spreads almost simultaneously inside the building (flames visible through each burnt window): Poor compartmentalization between floors, passage of flames through the floor slab and/or at the periphery of the Windows. A good compartmentalization allows a phase shift between the facade flames and the interior flames. Fire load of materials and air gap need to be checked.

# Next & Beyond.

**ALUCOBOND®**



**3A Composites GmbH**  
Alusingenplatz 1  
78224 Singen, Germany  
info@alucobond.com  
www.alucobond.com